

OLYMPUS OM-4 T

INSTRUCTIONS

Thank you for purchasing the OLYMPUS OM-4T . This new SLR camera employs titanium — a metal lighter and 6 times stronger than aluminum — in the construction of the main part of the body. It is the world's first 35 mm single lens reflex camera equipped with Multi Spot Metering and our new Full Synchro Flash System. This camera has been designed to facilitate serious photography with professional-level techniques including daylight synchro-flash photography, all with a minimum of effort: Its aim is to expand the sphere of creative photography. We recommend that before using the camera, you read this instruction manual carefully, confirming the instructions on the camera so that you can get the very best performance and service life from your new camera.

Note: All the components of the Olympus OM-4T are carefully designed and their production and assembly is strictly controlled to enhance the unmatched performance of the system. If any interchangeable lenses, flashes, or accessories other than Olympus products are used, Olympus cannot be responsible for poor results or damage of the OM-4T .

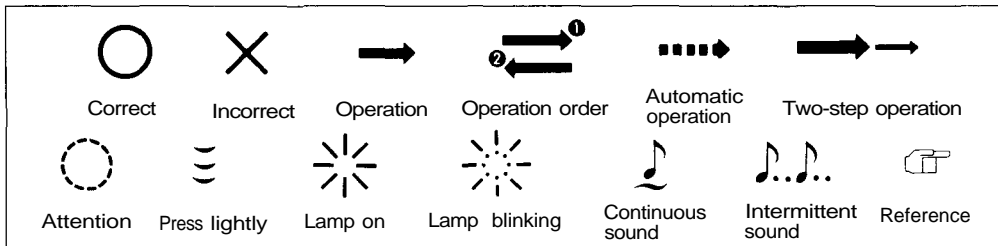

TABLE OF CONTENTS

< Preparations before Taking Pictures >	
● Dioptric Correction	4
● Mounting the Lens	6
● Loading the Batteries	8
● Checking the Batteries	9
● Loading the Film	11
● Setting the ISO Film Speed	15
< Taking Photographs (I) >	
—Automatic Exposure—	
● TTL Direct Light Metering	18
● Rewinding the Film	22
< Taking Photographs (II) >	
—Automatic Exposure—	
● How to Use the Spot Measurement	25
● How to Clear the Spot Metering	28
● How to Use the "Multi-Spot Measurement" Mode	29
● Highlight Control	32
● Shadow Control	35
< Taking Photographs (III) >	
—Automatic Exposure—	
● How to Use the Exposure Memory Lock System	39
< Taking Photographs (IV) >	
—Manual Exposure—	
● How to Take Picture on Center- Weighted, Averaged Metering	44
● How to Use the Spot Measurement	46
< Taking Photographs (V) >	
—Flash Photography—	
● Taking Daylight Synchro-Flash Photographs (Super FP Flash Mode)	50
< Other Operations >	
● Using the Self-Timer	55
● Exposure Compensation	56
● Bulb Exposure	57
● How to Shoot when the Batteries are Exhausted	58
● Using the Viewfinder Illuminator	60
● How to Turn Off the Beeper	61
● Changing the Focusing Screen	62
● Changing the Camera Back	64
● Attaching the Grip	65
● Handling Care	66
● Description of Controls	68
● Specifications	72

OM-4T

< Preparations before Taking Pictures >

Dioptric Correction

The OM-4T permits dioptric adjustment according to your eyesight.



1

Remove the body cap.



2

Pull out the diopter adjustment knob.



3

Turn and adjust the knob so that the matscreen appears sharp.

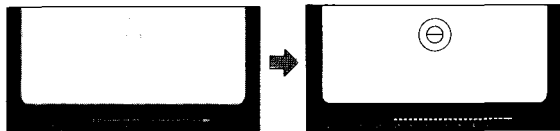

4

Push the knob back in until it locks.



Mounting the Lens



1

Remove the rear lens cap.



2

Align the red dots and rotate the lens clockwise until it locks.



3 Remove the front lens cap. (Press in the mount tabs on the edges of the lens cap parallel with "OLYMPUS").

Removing the Lens:



Press the lens release button and turn the lens counter-clockwise.

Loading the Batteries

Do not use different types of batteries or new and old batteries at the same time. If you are not likely to use the camera for a long period of time, remove the batteries before putting it away.

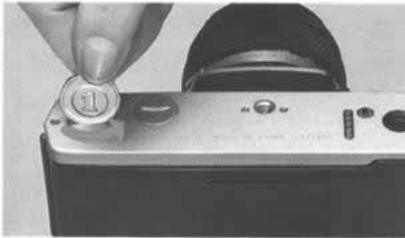

1

Remove the battery cover.

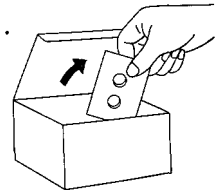



2

Wipe battery surfaces clean. Make sure that + signs are facing upwards.



Checking the Batteries

Always check the batteries after inserting new batteries, when shooting in cold weather, or if the camera has not been used for a long time.



1

Rotate the mode selector dial to the "BATTERY CHECK" position.

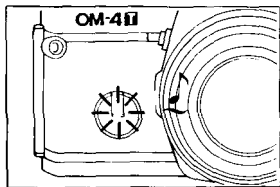

The audible and visual signals will tell you that the batteries have enough power. As the battery power weakens, the signals will become intermittent then vanish completely when they are exhausted. Replace the batteries.

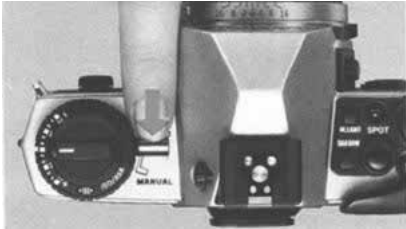

2

After the check, set back the dial.

When checking the batteries, the audible and visual signals will automatically turn off in 30 seconds. If you then press the shutter release, the shutter will trip in the auto exposure mode.

Loading the Film



1

Pull up on the rewind knob to open the camera back.

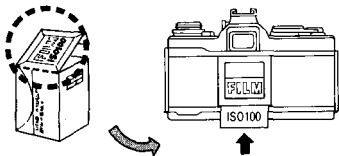

Tear off the top of the film box and insert it into the memo holder. It will remind you which film you are using.

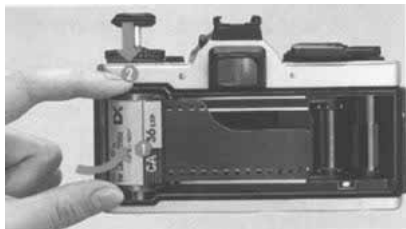

2

Insert the cartridge and push down the film rewind knob. (Always load the film in the shade.)



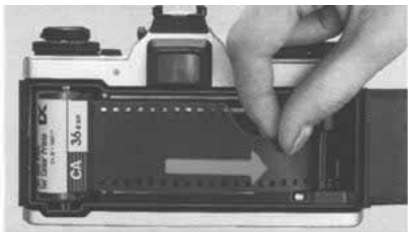

3

Insert the film leader into the take-up spool.

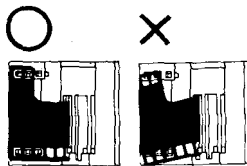

4

Wind the film and make sure the sprocket teeth catch both the upper and lower film perforations.



5

Take up the slack by turning the rewind crank clockwise.



6

Close the camera back until it clicks into place.



7

Face the camera toward light and take two blind shots. This will bring the film to the first frame.



YES

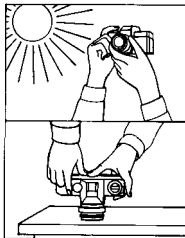

NO

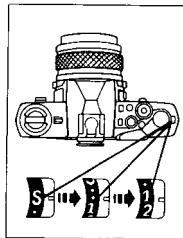

Setting the ISO Film Speed

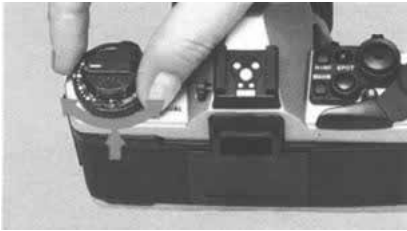

1

Lift up the outer collar and rotate until the ISO speed appears in the window.

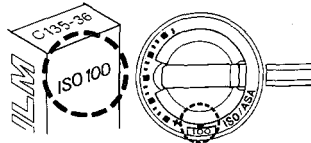

Film speed

(8) (16) (32) (80) (160) (320) (640) (1250) (2500)
6 ↓ 12 ↓ 25 ↓ 40 ↓ 64 ↓ 100 ↓ 200 ↓ 400 ↓ 800 ↓ 1600 ↓ 3200
(10) (20) (50) (125) (250) (500) (1000) (2000)

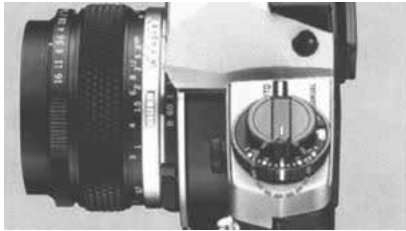

2

Align the exposure line A with the index B .

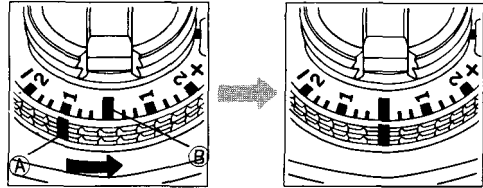

If the exposure compensation dial does not turn to the desired ISO number, set it once at an intermediate value then repeat the procedure.

OM-4T

< Taking Photographs (I) > — Automatic Exposure —

The OM-4T enables aperture-preferred automatic exposure on TTL direct light metering (center-weighted, averaged light metering). This mode can be used for most of the subjects under normal conditions — when shooting with the sun behind you, when the subject contrast is not too strong, and so forth.

TTL Direct Light Metering

Aperture-preferred automatic exposure allows you to take pictures by utilizing the lens depth of field effect (blurred background, for example).  P. 95



1



Set the mode selector lever to the "AUTO" position.



2

Set the aperture.

 Reference
P. 117

ISO 100			
F/ stop	16	8	4
Weather			

Basic aperture settings;

3

Press the shutter release lightly to activate the viewfinder display.

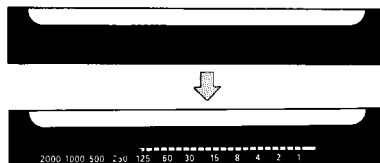

The bar tip indicates the shutter speed.



4

Focus on your subject.



5

Press the shutter release to take the picture.



A built-in battery conserver turns off the viewfinder display after 120 sec.



If you see an overexposure warning signal ("OVER" blinks), set the aperture to a larger number.

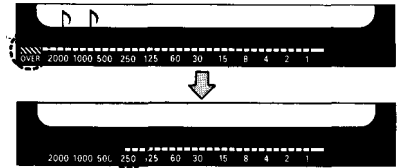

If the shutter speed is too slow, set the aperture to smaller number to prevent camera shake.

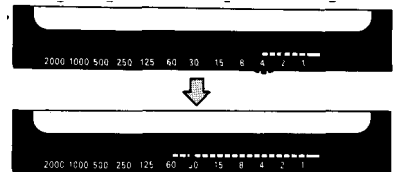

Rewinding the Film



1

When the exposure counter indicates the end of your roll of film.

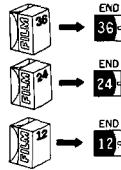

2

Push the "R" button.





3

Fold out the rewind crank and wind it until the film tension is released.



4

Open the camera back by pulling up on the rewind knob and remove the film.

OM-4T

Taking Photographs (II) — Automatic Exposure —

The spot metering system of the OM-4T enables you to control the exposure as you like. It insures perfect exposure of backlighted and high contrast subjects and expands shooting possibilities in the auto mode for more creative photography.

How to Use the Spot Measurement

 Reference
P. 96-100



- 1** Align the microprism area with the area you want to measure. (The spot metering range is outlined by the outer edge of the microprism.)

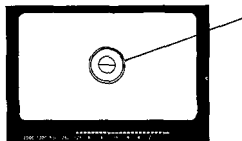

Spot metering range



2

Press the spot button to take meter reading. You will hear an electronic sound and the word "SPOT" will appear in the viewfinder. The metered value is displayed by the "◇" mark.

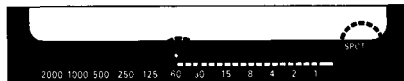

If you shift the camera, another "◇" mark will indicate the exposure value in the center of the frame along with the spot metered value.



3

Press the shutter release to take the picture.



4

The subject will turn out correctly exposed, regardless of the brightness of the background.

The spot metering mode will be automatically cleared after the shutter has tripped, or after 120 seconds have passed, and it will return to the, TTL direct light metering mode.

How to Clear the Spot Metering



1

With the lever at "CLEAR", the mode will return to TTL direct light metering.

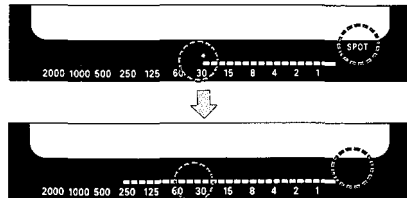

"SPOT" and "◇" mark disappear.

How to Use the "Multi-Spot Measurement" Mode

 Reference
P. 101-104

Spot metering is possible in up to 8 spots.



This sample photo shows a backlighted subject.



1

Take spot metering on the face (first spot).

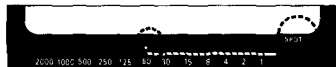
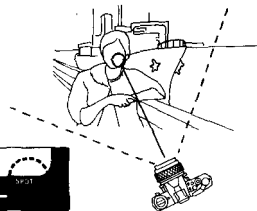

2

Take spot metering on the ship in the background (second spot).

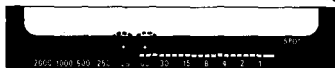
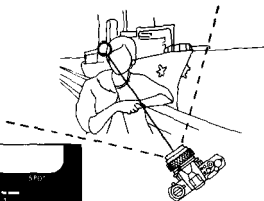



3 Compose your picture and press the shutter release.

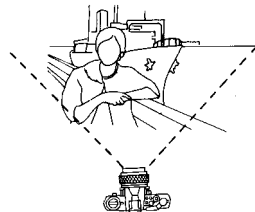

Both the subject and the background are correctly exposed.



To cancel the metered value, operate the clear lever.

Highlight Control

 Reference
P. 105-106

If you want to render white objects in white...

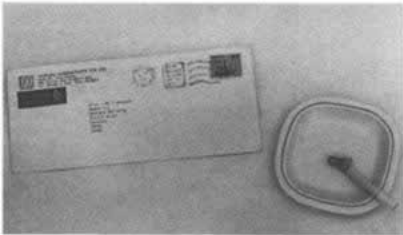

In ordinary shooting, white objects will turn out grayish if the picture is taken in strong brightness over the entire frame..



1

Take spot metering on the part of the subject which you want to render in white.

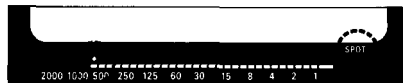

2

Press the HI. LIGHT button.

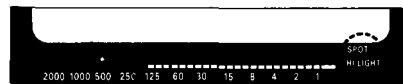

Exposure will be automatically corrected to give 2-step overexposure.



3

Press the shutter release to take the picture.



The white object turns out white.

The highlight control is cleared by pressing the HI. LIGHT button once again. To cancel the metered value, use the clear lever.

Shadow Control



Reference
P. 107-108

If you want to render black objects in black...



In ordinary shooting, black objects will turn out grayish if it is very dark over the entire picture frame.



1

Take spot metering on the spot which you want to render in black.



2

Press the SHADOW button.

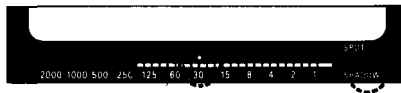

Exposure will be automatically corrected to give 2 2/3-step underexposure.



3

Press the shutter release to take the picture.



The black object turns out black.

The shadow control is cleared by pressing the SHADOW button once again. To cancel the metered value, use the clear lever.

OM-4T

Taking Photographs (III) — Automatic Exposure —

In automatic exposure, the same picture will be exposed with a very different exposure value if it is taken in different backgrounds. The OM-4T has an exposure memory lock system to solve this problem. It can be used in both the TTL direct metering and spot metering modes. Once an exposure value stored in memory, it does not vary even if you change the aperture (or shutter speed).

How to Use the Exposure Memory Lock System

 Reference
P. 109-110

The memory lock system is convenient for taking many pictures of the same subject in different backgrounds or costumes.



- 1 Operate the lever to set up the memory mode. The letters "MEMO" will appear in the viewfinder and the memory signal will blink twice.

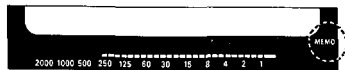
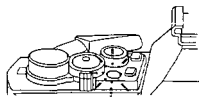



2

Frame the composition as you desire.



3

The Exposure Value is Stored in Memory after Shooting.

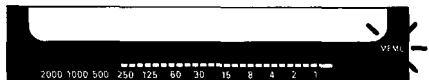

The memory will keep on for 60 minutes after the shutter has tripped.



4

Change the composition and shoot.



5

The subject is exposed with the same exposure value even if you change the composition.



6

To clear the memory, use the clear lever.

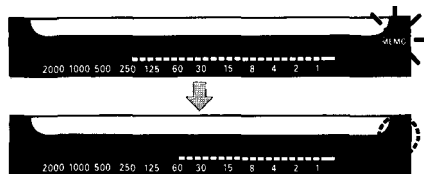

The memory is also cleared in the following cases:

1. When a lens is mounted or dismounted.
2. When the mode lever is switched.

OM-4T

Taking Photographs (IV) — Manual Exposure —

The OM-4T permits manual exposure on center-weighted, averaged metering and spot metering. It allows you to choose the optimum aperture and shutter speed which suit your subject and taste.

How to Take Pictures on Center-Weighted, Averaged Metering



- 1 Set the mode selector dial to the "MANUAL" position.



2

Set the bar graph tip to the fixed point between the arrows by adjusting the aperture and/or shutter speed rings.



3

Fixed point

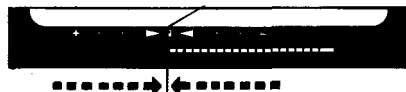

The shutter speed you have set will be displayed in the viewfinder.



4



Shoot.

How to Use the Spot Measurement

 Reference
P.96-100



- 1 Align the microprism area with the area you want to measure.

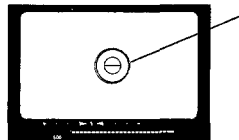

Spot metering range



2

Press the spot button to take meter reading.



3

Set the bar graph tip to the fixed point between the arrows by adjusting the aperture and/or shutter speed rings.

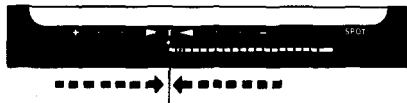

4

The shutter speed you have set will be displayed in the viewfinder.

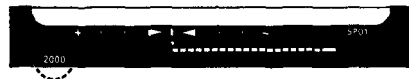



5

Shoot.



6

The subject will turn out correctly exposed, regardless of the brightness of the background.

It is also possible to use the multi-spot metering, highlight control and shadow control. In any case, correct exposure is obtained by simply setting the bar graph at the fixed point.

OM-4T

< Taking Photographs (V) >
— Flash Photography —

The OM-4T is the perfect companion for the world's first Full Synchro Flash F280. Professional standards are within the reach of every owner, even during daylight synchro — flash photography — an area which has traditionally required considerable skill.

Taking Daylight Synchro-Flash Photographs (Super FP Flash Mode)

For OTF Auto using the Normal OTF Flash mode, refer to the F280 instruction manual.



1 Slide the F280 into the accessory shoe and secure it with the lock screw.



2

Turn the power switch ON.



3

Check the charge indicator.



4

Set the mode switch to SUPER FP.





5

Set the camera mode to AUTO.



6

Select an aperture that results in a shutter speed faster than 1/60 sec. (for slower speeds consult the F280 manual).



7

Press the shutter release.



8

Confirm a correct exposure by checking the indicator.

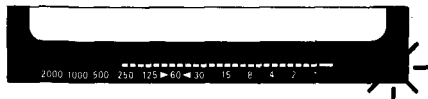

OM-4T

< Other Operations >

Using the Self-Timer



1

Push the lever down outward.



2

Press the shutter release to start the self-timer.
The shutter will fire in 12 seconds.

The shutter will trip immediately if the self-timer lever is returned while it is running.

Exposure Compensation

 Reference
P. 116



1 When an exposure compensation is set, the indicator lights in the viewfinder.

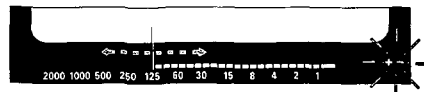

2 After shooting, return the dial to its original position.

Bulb Exposure

 Reference
P. 120



1

While pressing the "B" lock button, turn and set the shutter speed dial to "B".

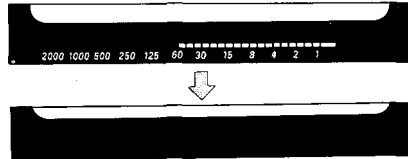

The display in the view finder disappears.



2

The shutter will remain open as long as the shutter release button is held depressed.

How to Shoot when the Batteries are Exhausted

If the batteries are exhausted and you do want to take pictures immediately, use the mechanical shutter speed of 1/60 sec.



1 While pressing the "B" lock button, rotate the shutter ring to the red "60" position.



2 Shoot. The mechanical shutter will operate to trip at 1/60sec.

You cannot use the motor drive, winders and flashes with the mechanical shutter.

Using the Viewfinder Illuminator



1

Push the button if the viewfinder display is too dark to read.

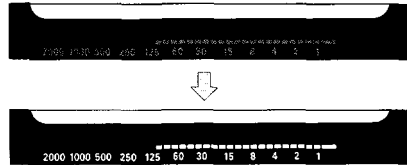

How to Turn Off the Beeper



1

To turn off the audible signal, push the lever to the right (in the direction of the arrow).

You will no longer hear PCV sounds when turning on the spot metering, highlight and shadow controls, when operating the memory/clear lever, checking the batteries, or when mounting and dismounting the lens.

Changing the Focusing Screen

 Reference
P. 139-140

14 screens are available to cover a wide range of applications.

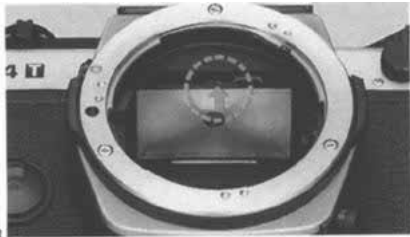

1

Pull down the screen frame.
Pull the lug at top inside the body mount toward you to swing down the screen frame.

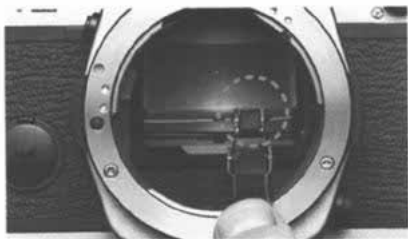

2 To change the focusing screen, use the tweezers supplied with an optional focusing screen. Push the frame upward until you hear a click.

Changing the Camera Back

The camera back is interchangeable with the Recordata Back or 250 Film Back.

 P. 133



- 1 Open the camera back. Press down on the camera back release button and remove the camera back.

Removing

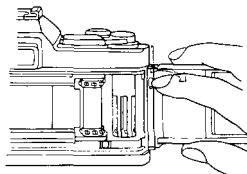

Attaching

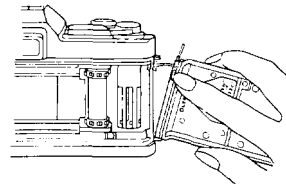

Attaching the Grip



1

Attach the Camera Grip 1 (optional accessory).

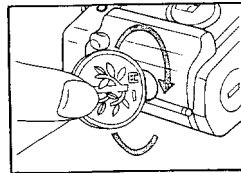

When using a motor drive or winders, detach the Grip.

Storage Care

Guard against high temperature and magnetic fields.

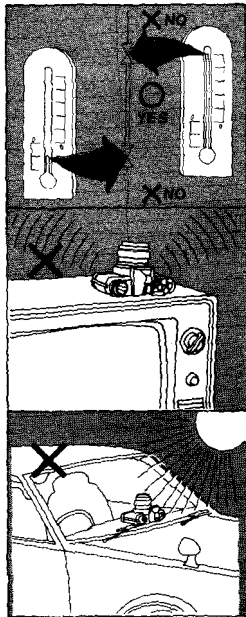

Battery Precaution

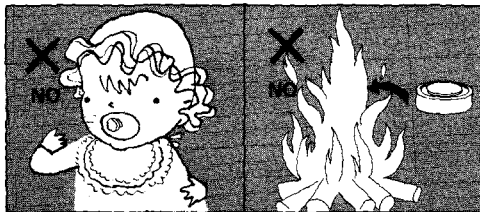

Description of Controls

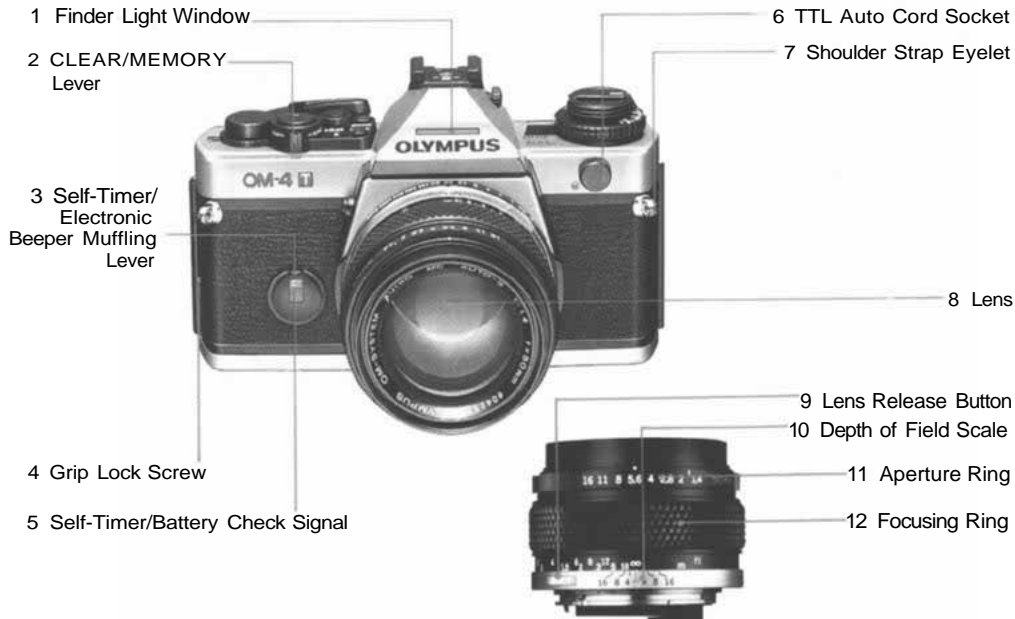

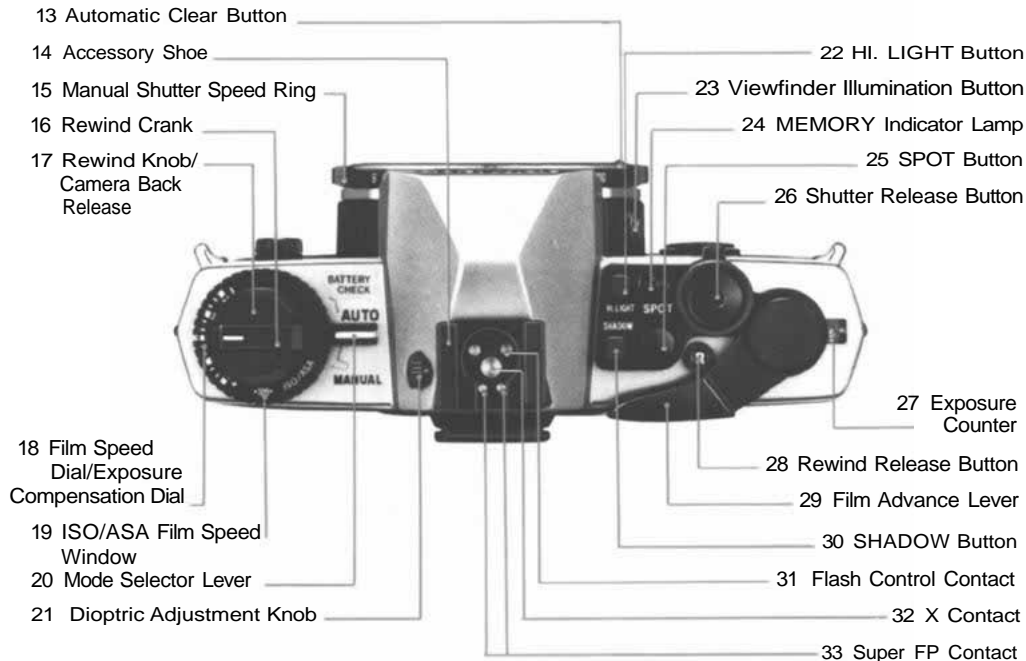

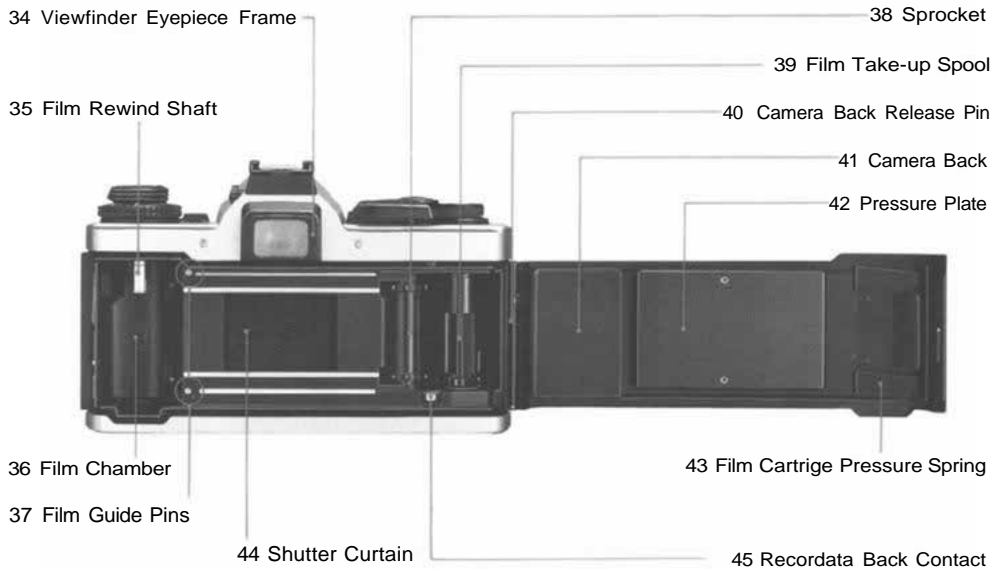

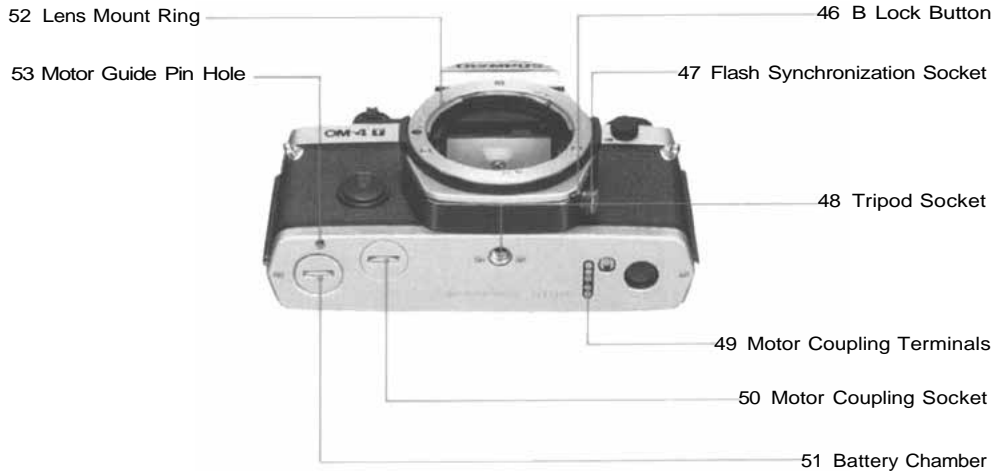

Specifications

Type: TTL auto-exposure 35mm SLR camera

Film Format: 24mm x 36mm

Lens mount: Olympus OM mount

Shutter: Electronically controlled cloth focal plane shutter; 1/2000 sec. max. shutter speed; 1/60 sec. mechanical shutter speed

Synchronization: X contact (synchronization at speeds of 1/60 sec. or slower); Super FP Flash contact; Hot shoe (with X and Super FP Flash contacts); 5-pin connector for T-series flash, synchro socket for X

Light measuring method: Center-weighted, average light measurement, switchable to spot measurement; spot measurement selective in 3 modes; multi-spot, highlight-and shadow-based methods.

Automatic exposure control by average light measurement: TTL Direct "off-the-film" Light Measuring with aperture-preferred electronic shutter; exposure control range: about 1 min. ~1/2000 sec. light measuring range: approx. EV-5 ~ EV19 (ISO 100, 50mm F1.4, normal temperature and humidity); ± 2 EV exposure compensation.

Automatic exposure control by spot measurement: TTL spot metering memory system (with AE lock); exposure control range: about 4 min. ~ 1/2000 sec. light measuring range: approx. EV 0 — EV 19 (ISO 100, 50mm F1.4, normal temperature and humidity); ± 2 EV exposure compensation.

Automatic exposure memory control: Exposure value memory system (60 min. limiter)

Manual exposure control: B, 1 sec.~1/2000 sec. mechanical exposure speed 1/60 sec.

Flash exposure control: Super FP Flash mode (when using the Full Synchro Flash F280) "OTF" AUTO: Synchronizes with shutter speeds from 1/60 sec. to 1/2000 sec.; MANUAL: Synchronizes with all shutter speeds up to 1/2000 sec.; Normal "OTF" or Manual Flash mode (when using a T-series Flash or Full Synchro Flash F280) Synchronizes with shutter speeds of 1/60 sec. and slower.

Film speed: ISO 6 ~ 3200

Film-advance: Film advance lever with 130° angle for one long or several short strokes and pre-advance angle 30°; motor drive and winder usable

Film rewind: Rewind crank (motorized rewind with Motor Drive 2 possible)

Viewfinder: Viewfinder with dioptic correction; dioptic correction range +1.0 ~ -3.0 diopters; interchangeable focusing screens; microprism/split image-matte type screen standardized; finder view field: 97% of actual picture field; magnification: 0.84X at infinity with -0.5 diop. and 50mm lens

Viewfinder information: LCD multi-mode display (2-min. limiter); built-in illuminator, (10-sec. limiter)

Self-timer: 12-sec. delay electronic self-timer

Battery check: 3-level display with LED and alarm sound; automatic lock with batteries exhausted

Power Source: Two 1.5V silver-oxide batteries SR44 (Eveready EPX-76; alkaline manganese batteries LR44 or equivalent)

Camera back: Removable hinge type, with memo holder; interchangeable with Recordata Backs and 250 Film Back

Dimensions: 136 x 84 x 50mm (5.35" x 3.30" x 1.97") (body alone)

Weight: 510g (18 oz.) (body alone)



OLYMPUS

OLYMPUS OPTICAL CO., LTD.

San-Ei Building, 22-2, Nishi Shinjuku 1-chome, Shinjuku-ku Tokyo, Japan Tel. 03-340-2211

OLYMPUS CORPORATION

Crossways Park, Woodbury, New York 11797, U.S.A. Tel. 516-364-3000

OLYMPUS OPTICAL CO. (EUROPA) GMBH

Postfach 104908, Wendenstrasse 14-16, 2 Hamburg 1, West Germany. Tel. 040-2-3773-0

OLYMPUS OPTICAL CO. (UK) LTD.

2-8 Honduras Street, London EC1Y 0TX, England. Tel. 01-253-2772